

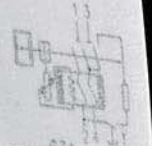

ABL SURSUM

RCCB RW2203  
25A I<sub>n</sub> 30mA  
~230V I<sub>m</sub> 500A



63A  
10000  
Typ AC

Test  
halbjährlich  
half-yearly

T

# PROTECTION

---

## RCCB AND RCBOS

### **RCCB**

<b>RW product range</b>	42
Sensitive to alternating currents, Type AC	42
Undelayed tripping	42
Short-time delayed tripping	45
Selective tripping	45

### **RP product range**

Sensitive to pulsating currents, Type A	46
Undelayed tripping	46
Short-time delayed tripping	47
Selective tripping	48

### **RA product range**

Sensitive to universal current, Type B	50
Short-time delayed tripping	50
Selective tripping	51
Auxiliary contact	52
Technical data RP und RW	53
General explanations	57
Technical features and application notes	59

### **RCBO**

<b>RC and RB product range</b>	65
Auxiliary contact	65
Busbars	66
Technical Data	67

# RCCB – SENSITIVE TO ALTERNATING CURRENT TYPE AC

RW product range, undelayed tripping acc. to IEC 61008

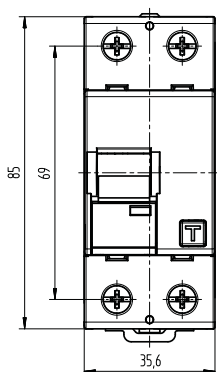

RW product range, 2-pole

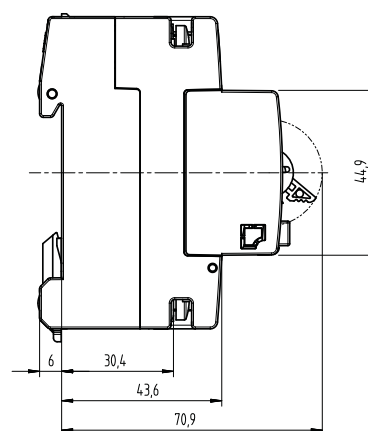
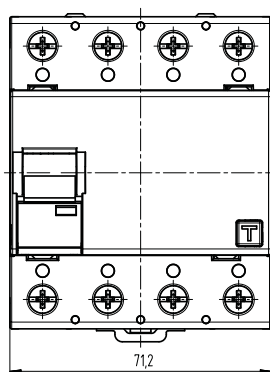

RW product range, 4-pole

## Function

RCCB independent of the mains voltage for realising the protective measure "protection through automatic power supply cut-off", in compliance with the requirements of international construction regulations.

## Characteristics

- 2-pole or 4-pole
  - Large range of products with
    - Rated currents from 16 A to 125 A
    - Rated residual currents 0.03 A to 0.5 A
  - Tripping independent of supply and auxiliary voltage
  - Sensitive to AC residual currents (type AC)
  - High short-circuit strength
  - Double-sided two-tier terminals for large conductor cross-section and busbar
  - Switch-position display
  - Window for labels
  - Multi-functional switching knob with three functions:
    - **On** (top position)
    - **Off** (bottom position)
    - Display **"tripped"** (centre position)
- If the RCCB trips due to a fault, the switching knob stays in the centre position

## Type of mounting

- Quick mounting on DIN-rail in accordance with EN 60715 in any standard distribution
- Any mounting position

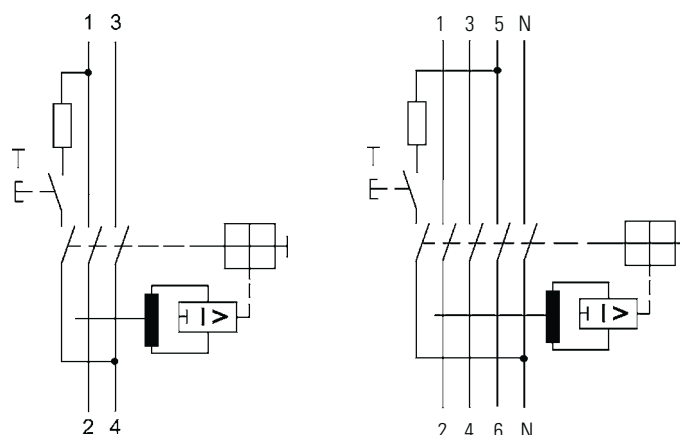

RW product range, 2-pole

RW product range, 4-pole 25-80 A

## Areas of application

Power supplies of residential and single-purpose buildings as well as industrial facilities with TN-S and TN-C-S networks. In IT networks, RCCBs of the RW series for switch-off in case of a second failure can be provided for. Excluded is the use in TN-C networks and for protecting systems in which electronic equipment might cause DC residual currents or residual currents with frequencies of  $\neq 50$  Hz.

# RCCB – SENSITIVE TO ALTERNATING CURRENT TYPE AC

Undelayed tripping acc. to IEC 61008

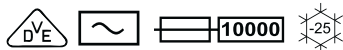

This product range differentiates between:

- Standard products (**shown in the table in bold**)
- Special products (shown in the table in normal print – longer delivery time)

RATED RESID. CURRENT $I_{\Delta n}$ mA	RATED CURRENT $I_n$ A	SURGE CURRENT STRENGTH > A	MAX. BACK-UP FUSE A	MODULES	ARTICLE NO.	WEIGHT g/EACH	PACKING UNIT
--	-----------------------	----------------------------	---------------------	---------	-------------	---------------	--------------

2-pole, undelayed tripping							
30	16	250	63	2	<b>RW2103</b>	250	1
100	16	250	63	2	RW2110	250	1
300	16	250	63	2	RW2130	250	1
30	25	250	63	2	<b>RW2203</b>	250	1
100	25	250	63	2	RW2210	250	1
300	25	250	63	2	RW2230	250	1
30	40	250	63	2	<b>RW2303</b>	260	1
100	40	250	63	2	RW2310	260	1
300	40	250	63	2	RW2330	260	1
30	63	250	100	2	<b>RW2403</b>	270	1
100	63	250	100	2	RW2410	270	1
300	63	250	100	2	RW2430	270	1

# RCCB – SENSITIVE TO ALTERNATING CURRENT TYPE AC

Undelayed tripping acc. to IEC 61008

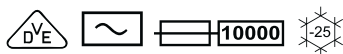

This product range differentiates between:

- Standard products (**shown in the table in bold**)
- Special products (shown in the table in normal print – longer delivery time)

RATED RESID. CURRENT $I_{\Delta n}$ mA	RATED CURRENT $I_n$ A	SURGE CURRENT STRENGTH > A	MAX. BACK- UP FUSE A	MODULES	ARTICLE NO.	WEIGHT g/EACH	PACKING UNIT
--	-----------------------------	----------------------------------	----------------------------	---------	-------------	------------------	-----------------

4-pole, undelayed tripping							
<b>30</b>	<b>16</b>	<b>250</b>	<b>63</b>	<b>4</b>	<b>RW4103</b>	<b>450</b>	<b>1</b>
<b>100</b>	<b>16</b>	<b>250</b>	<b>63</b>	<b>4</b>	<b>RW4110</b>	<b>450</b>	<b>1</b>
<b>300</b>	<b>16</b>	<b>250</b>	<b>63</b>	<b>4</b>	<b>RW4130</b>	<b>450</b>	<b>1</b>
<b>30</b>	<b>25</b>	<b>250</b>	<b>63</b>	<b>4</b>	<b>RW4203</b>	<b>450</b>	<b>1</b>
<b>100</b>	<b>25</b>	<b>250</b>	<b>63</b>	<b>4</b>	<b>RW4210</b>	<b>450</b>	<b>1</b>
<b>300</b>	<b>25</b>	<b>250</b>	<b>63</b>	<b>4</b>	<b>RW4230</b>	<b>450</b>	<b>1</b>
<b>30</b>	<b>40</b>	<b>250</b>	<b>63</b>	<b>4</b>	<b>RW4303</b>	<b>450</b>	<b>1</b>
<b>100</b>	<b>40</b>	<b>250</b>	<b>63</b>	<b>4</b>	<b>RW4310</b>	<b>450</b>	<b>1</b>
<b>300</b>	<b>40</b>	<b>250</b>	<b>63</b>	<b>4</b>	<b>RW4330</b>	<b>450</b>	<b>1</b>
<b>30</b>	<b>63</b>	<b>250</b>	<b>100</b>	<b>4</b>	<b>RW4403</b>	<b>450</b>	<b>1</b>
<b>100</b>	<b>63</b>	<b>250</b>	<b>100</b>	<b>4</b>	<b>RW4410</b>	<b>450</b>	<b>1</b>
<b>300</b>	<b>63</b>	<b>250</b>	<b>100</b>	<b>4</b>	<b>RW4430</b>	<b>450</b>	<b>1</b>
<b>30</b>	<b>80</b>	<b>250</b>	<b>125</b>	<b>4</b>	<b>RW4503</b>	<b>470</b>	<b>1</b>
<b>300</b>	<b>80</b>	<b>250</b>	<b>125</b>	<b>4</b>	<b>RW4530</b>	<b>470</b>	<b>1</b>
<b>500</b>	<b>80</b>	<b>250</b>	<b>125</b>	<b>4</b>	<b>RW4550</b>	<b>470</b>	<b>1</b>
<b>30</b>	<b>100</b>	<b>250</b>	<b>125</b>	<b>4</b>	<b>RW4603</b>	<b>470</b>	<b>1</b>
<b>100</b>	<b>100</b>	<b>250</b>	<b>125</b>	<b>4</b>	<b>RW4610</b>	<b>470</b>	<b>1</b>
<b>300</b>	<b>100</b>	<b>250</b>	<b>125</b>	<b>4</b>	<b>RW4630</b>	<b>470</b>	<b>1</b>
<b>30</b>	<b>125</b>	<b>250</b>	<b>125</b>	<b>4</b>	<b>RW4703</b>	<b>470</b>	<b>1</b>
<b>100</b>	<b>125</b>	<b>250</b>	<b>125</b>	<b>4</b>	<b>RW4710</b>	<b>470</b>	<b>1</b>
<b>300</b>	<b>125</b>	<b>250</b>	<b>125</b>	<b>4</b>	<b>RW4730</b>	<b>470</b>	<b>1</b>
<b>500</b>	<b>125</b>	<b>250</b>	<b>125</b>	<b>4</b>	<b>RW4750</b>	<b>470</b>	<b>1</b>

## RCCB – SENSITIVE TO ALTERNATING CURRENT TYPE AC

Short-time delayed tripping acc. to IEC 61008



RATED RESID. CURRENT $I_{\Delta n}$ mA	RATED CURRENT $I_n$ A	SURGE CURRENT STRENGTH > A	MAX. BACK-UP FUSE A	MODULES	ARTICLE NO.	WEIGHT g / EACH	PACKING UNIT
--	-----------------------------	-------------------------------	------------------------	---------	-------------	--------------------	--------------

4-pole, short-time delayed tripping							
30	40	3,000	63	4	RW4303K	450	1
30	63	3,000	100	4	RW4403K	450	1

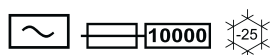

## RCCB – SENSITIVE TO ALTERNATING CURRENT TYPE AC

Selective tripping acc. to IEC 61008



RATED RESID. CURRENT $I_{\Delta n}$ mA	RATED CURRENT $I_n$ A	SURGE CURRENT STRENGTH > A	MAX. BACK-UP FUSE A	MODULES	ARTICLE NO.	WEIGHT g / EACH	PACKING UNIT
--	-----------------------------	-------------------------------	------------------------	---------	-------------	--------------------	--------------

4-pole, short-time delayed tripping							
300	40	5,000	63	4	RW4330S	450	1
300	63	5,000	100	4	RW4430S	450	1
300	100	5,000	125	4	RW4630S	450	1
300	125	5,000	125	4	RW4730S	450	1

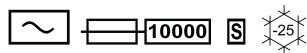

# RCCB – SENSITIVE TO PULSATING CURRENTS, TYPE A

RP product range, undelayed tripping acc. to IEC 61008

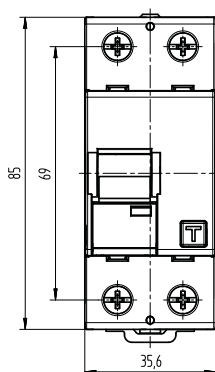

RP product range, 2-pole

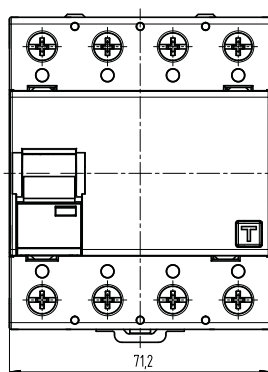

RP product range 4-pole

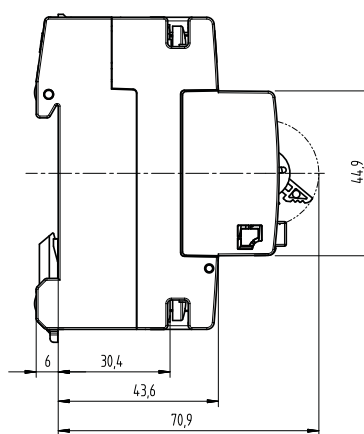

## Function

RCCB independent of the mains voltage for realising the protective measure "protection through automatic power supply cut-off", in compliance with the requirements of VDE 0100 part 410 and corresponding international construction regulations.

## Characteristics

- 2-pole or 4-pole
- Large range of products with
  - Rated currents from 16 A to 125 A
  - Rated residual currents 0.03 A to 0.5 A
- Tripping independent of supply and auxiliary voltage
- Sensitive to AC and pulsating DC residual currents (type A)
- High short-circuit strength
- Double-sided two-tier terminals for large conductor cross-section and busbar
- Switch-position display
- Window for labels
- Multi-functional switching knob with three functions:
  - **On** (top position)
  - **Off** (bottom position)
  - Display "**tripped**" (centre position)

If the RCCB trips due to a fault, the switching knob stays in the centre position.

## Type of mounting

- Quick mounting on DIN-rail according to EN 60715 in any standard distribution
- Any mounting position

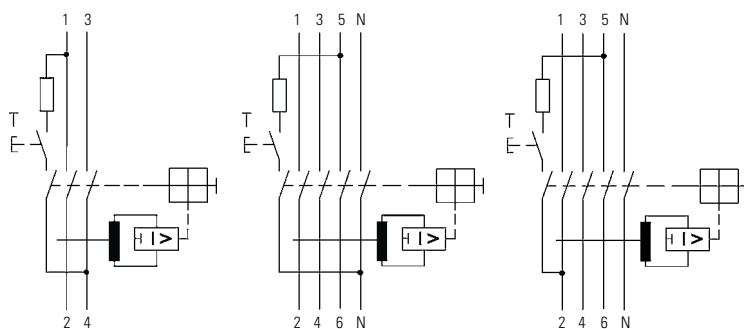

RP product range, 2-pole

RP product range, 4-pole  
25-80 A

## Areas of application

Power supplies of residential and single-purpose buildings as well as industrial facilities with TN-S and TN-C-S networks. In IT networks, RCCBs of the RP range for switch-off in case of a second fault can be provided for.

The use in TN-C networks and for protecting systems in which electronic equipment might cause DC residual currents or residual currents with frequencies of  $\neq 50$  Hz is excluded.

# RCCB – SENSITIVE TO PULSATING CURRENTS, TYPE A

Undelayed tripping acc. to IEC 61008

This product range differentiates between:

- Standard products (**shown in the table in bold**)
- Special products (shown in the table in normal print – longer delivery time)

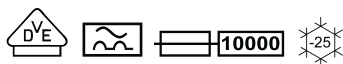

RATED RESID. CURRENT $I_{\Delta n}$ mA	RATED CURRENT $I_n$ A	SURGE CURRENT STRENGTH > A	MAX. BACK-UP FUSE A	MODULES	ARTICLE NO. N-POL RIGHT	ARTICLE NO. N-POL LEFT	WEIGHT g / EACH	PACKING UNIT
<b>2-pole, undelayed tripping</b>								
10	<b>16</b>	250	50	2	<b>RP2101</b>		270	1
30	<b>25</b>	250	100	2	<b>RP2203</b>		270	1
300	<b>25</b>	250	100	2	<b>RP2230</b>		270	1
30	<b>40</b>	250	100	2	<b>RP2303</b>		270	1
300	<b>40</b>	250	100	2	<b>RP2330</b>		270	1
30	<b>63</b>	250	100	2	RP2403		270	1
300	<b>63</b>	250	100	2	RP2430		270	1
500	<b>63</b>	250	100	2	RP2450		270	1



RATED RESID. CURRENT $I_{\Delta n}$ mA	RATED CURRENT $I_n$ A	SURGE CURRENT STRENGTH > A	MAX. BACK-UP FUSE A	MODULES	ARTICLE NO. N-POL RIGHT	ARTICLE NO. N-POL LEFT	WEIGHT g / EACH	PACKING UNIT
<b>4-pole, undelayed tripping</b>								
30	<b>25</b>	250	100	4	<b>RP4203</b>	<b>RP4203L</b>	450	1
300	<b>25</b>	250	100	4	<b>RP4230</b>	<b>RP4230L</b>	420	1
500	<b>25</b>	250	100	4	<b>RP4250</b>	<b>RP4250L</b>	420	1
30	<b>40</b>	250	100	4	<b>RP4303</b>	<b>RP4303L</b>	450	1
300	<b>40</b>	250	100	4	<b>RP4330</b>	<b>RP4330L</b>	420	1
500	<b>40</b>	250	100	4	<b>RP4350</b>	<b>RP4350L</b>	420	1
30	<b>63</b>	250	100	4	<b>RP4403</b>	<b>RP4403L</b>	450	1
300	<b>63</b>	250	100	4	<b>RP4430</b>	<b>RP4430L</b>	420	1
500	<b>63</b>	250	100	4	<b>RP4450</b>	<b>RP4450L</b>	420	1
30	<b>80</b>	250	125	4	<b>RP4503</b>		460	1
300	<b>80</b>	250	125	4	<b>RP4530</b>		430	1
500	<b>80</b>	250	125	4	RP4550		430	1
30	<b>100</b>	250	125	4	RP4603		460	1
300	<b>100</b>	250	125	4	RP4630		430	1
500	<b>100</b>	250	125	4	RP4650		430	1
30	<b>125</b>	250	125	4	<b>RP4703</b>		460	1
300	<b>125</b>	250	125	4	<b>RP4730</b>		430	1
500	<b>125</b>	250	125	4	RP4750		430	1



## RCCB – SENSITIVE TO PULSATING CURRENTS, TYPE A

Short-time delayed tripping acc. to IEC 61008

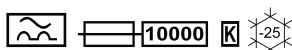

RATED RESID. CURRENT $I_{\Delta n}$ mA	RATED CURRENT $I_n$ A	SURGE CURRENT STRENGTH > A	MAX. BACK-UP FUSE A	MODULES	ARTICLE NO.	WEIGHT g / EACH	PACKING. UNIT
--	-----------------------------	-------------------------------	------------------------	---------	-------------	--------------------	------------------

4-pole, short-time delayed tripping							
30	40	3.000	100	4	RP4303K	430	1
30	63	3.000	100	4	RP4403K	430	1

### Areas of application

- Power supplies of residential and single-purpose buildings as well as industrial facilities with TN-S and TN-C-S networks, where normal RCCBs unwantedly trip as a result of transient drainage currents, such as
- Systems with long cable lengths behind the RCCB
- Lighting systems with many fluorescent lamps (> 20 pieces)
- Computer systems
- Solaria
- X-ray systems
- The use in TN-C networks and in systems in which electronic equipment might cause smooth DC residual currents or residual currents with frequencies of  $\neq$  50 Hz is excluded.

## RCCB – SENSITIVE TO PULSATING CURRENTS, TYPE A

Selective tripping acc. to IEC 61008

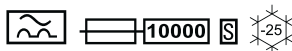

RATED RESID. CURRENT $I_{\Delta n}$ mA	RATED CURRENT $I_n$ A	SURGE CURRENT STRENGTH > A	MAX. BACK-UP FUSE A	MODULES	ARTICLE NO.	WEIGHT g / EACH	PACKING. UNIT
--	-----------------------------	-------------------------------	------------------------	---------	-------------	--------------------	------------------

4-pole, selective tripping							
300	40	5.000	100	4	RP4330S	430	1
300	63	5.000	100	4	RP4430S	450	1
300	100	5.000	125	4	RP4630S	460	1
300	125	5.000	125	4	RP4730S	460	1

### Areas of application

Main distributors in extended electricity supply systems with TN-S and TN-C-S systems, e.g. for

- Camping sites
- Marinas
- Allotment colonies
- Fairgrounds
- etc.

Here, selective RCCBs mostly protect the cables from the main distribution to the sub-distributions. The use in TN-C networks and in systems in which electronic equipment might cause smooth DC residual currents or residual currents with frequencies of  $\neq$  50 Hz is excluded.

### Notes

To ensure the selectivity of the RCCB, the rated residual current of the RP4xxxS must be selected at least one level higher than that of the undelayed switch connected downstream.

# RCCB – SENSITIVE TO UNIVERSAL CURRENT, TYPE B

RA product range – short-time delayed tripping acc. to IEC 61008

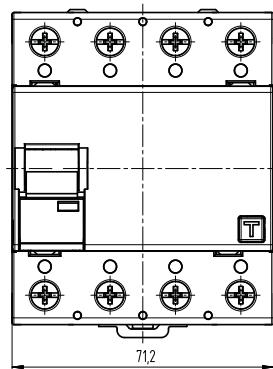

RAxxx product range, 4-pole  
25 to 80 A

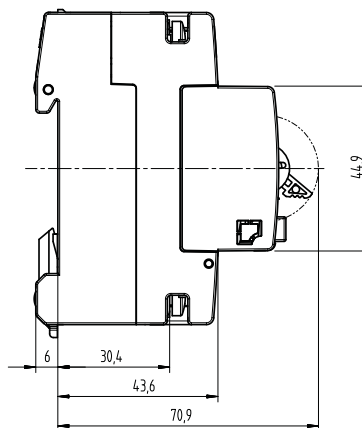

RAxxx product range, 4-pole  
100 to 125 A

## Function

RCCB sensitive to universal current for realising the protective measure "protection through automatic power-supply cut-off" in systems with electronic equipment, in compliance with the requirements of VDE 0100-410, VDE 0160, and corresponding international construction regulations. In addition to the mains-voltage-independent detection of AC and pulsating DC residual currents, all units of the RA4xxx product range are also able to detect smooth DC residual currents.

For this purpose, a voltage > 30 V between only two user-defined current paths is sufficient. The circuit breaker thus complies with type B according to IEC TR 60755.

Beyond this requirement, the RA4 consistently detects residual currents of all frequencies up to 1 MHz. With its low requirements concerning the auxiliary voltage and its large frequency range of residual current detection, this residual current circuit breaker clearly exceeds the requirements of the construction standard for B-type RCCBs, E DIN VDE 0664-100.

The frequency response of the RA4xxx tripping current (see figure on page 53) is designed such that residual currents with high frequencies, e.g. in the range of the pulse frequencies of frequency converters, are detected with clearly reduced sensitivity.

This largely prevents false tripping through drainage currents. However, even with residual currents of these frequencies, protection in case of indirect contact (fault protection) in compliance with VDE 0100-410 is realisable. The defined tripping threshold for all frequencies of up to 1 MHz always enables the definition of a maximum earth resistance, so that – in the event of fault – any inadmissibly high touch voltage will be switched off fast.

The devices of this range have different frequency responses for residual current tripping. In cases where capacitive drainage currents with the pulse frequencies of electronic equipment cause false tripping of the NK-type circuit breakers, an RA4xxx switch allows for mostly fault-free operation.

Even for rated residual currents  $\leq 0.3$  A, however, fire protection is only given for frequencies of up to approx. 1 kHz.

With this switch, protection in case of indirect contact, i.e. fault protection according to VDE 0100-410, can be realised at corresponding earth resistances throughout the entire frequency range of residual current tripping. The maximum permissible earth resistances result, as quotients, from the permissible touch voltage and the highest residual response current in the entire frequency range comprised.

# RCCB – SENSITIVE TO UNIVERSAL CURRENT, TYPE B

RA product range – short-time delayed tripping acc. to IEC 61008

## Characteristics

- 4-pole
- Sensitive to universal current for residual currents with frequencies and mixed frequencies from 0 to 1 MHz
- Large range of products with
  - Rated currents from 25 A to 125 A
  - Rated residual currents 0.03 A to 0.5 A
- Small size for all rated currents
- VDE test mark approved in compliance with
- DIN VDE 0664-10/E DIN VDE 0664-100
- Very unsusceptible to transient drainage and residual currents, due to delayed tripping response
- Electromagnetic compatibility in compliance with VDE 0664-30 and VDE 0839 6-2 (interference resistance for industrial use)
- High availability, also of the voltage-dependent detection of smooth DC and AC residual currents with frequencies  $\neq$  50/60 Hz, due to full operability with mains voltages above 30 V, applied to any 2 current paths only
- Tripping at residual currents of type A, independent of mains voltage
- High short-circuit strength
- Double-sided two-tier terminals for large conductor cross-section and busbar connection
- Switch-position display
- Multi-functional switching knob with three functions:
  - **On** (top position)
  - **Off** (bottom position)
  - Display **"tripped"** (centre position)
- If the RCCB trips due to a fault, the switching knob stays in the centre position
- Window for labels

## Type of mounting

- Quick mounting on DIN-rail in accordance with EN 60715 in any standard distribution
- Any mounting position
- Infeed direction from above (N, 1, 3, 5)

## Areas of application

Commercial and industrial installations with TN-S and TN-C-S systems where power electronics equipment without galvanic mains separation is used, such as:

- Frequency converters
- UPS systems
- Switched-mode power supplies
- High-frequency converters
- On-site power supply distribution boards
- Photovoltaic systems

## Note

**Not intended for use in DC power supplies!**

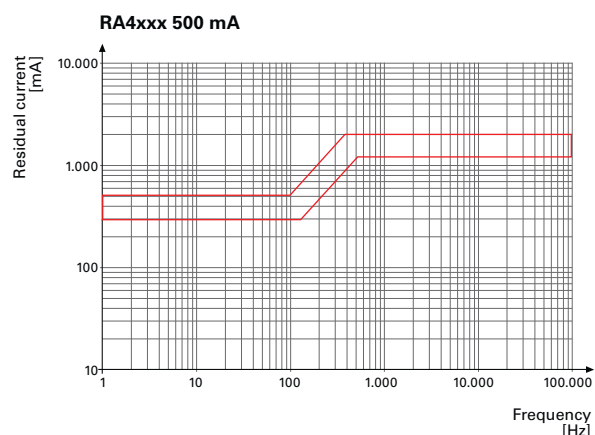
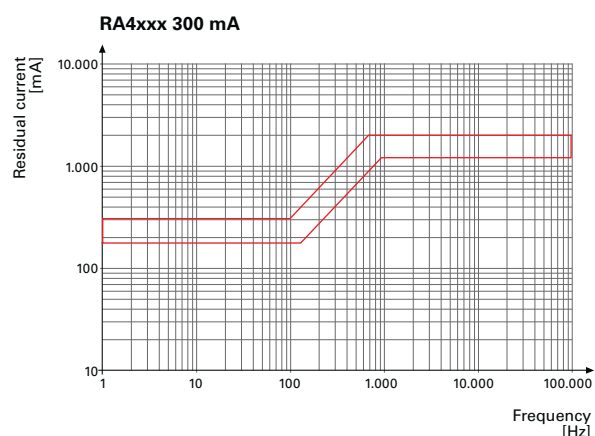
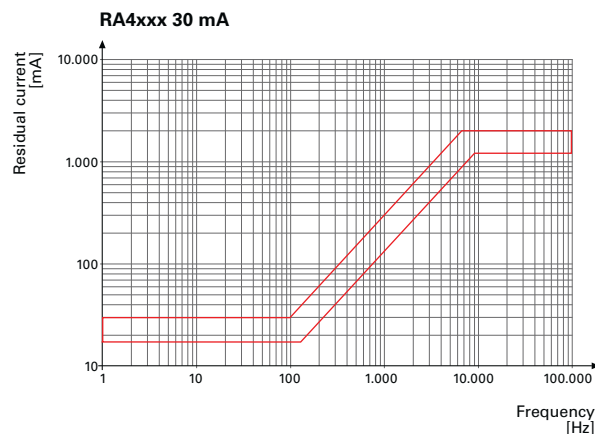

# RCCB – SENSITIVE TO UNIVERSAL CURRENT, TYPE B

Short-time delayed tripping acc. to IEC 61008

This product range differentiates between:

- Standard products (**shown in the table in bold**)
- Special products (shown in the table in normal print – longer delivery time)

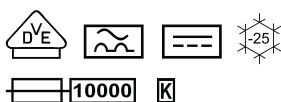

RATED RESID. CURRENT $I_{\Delta n}$ mA	RATED CURRENT $I_n$ A	SURGE CURRENT STRENGTH > A	MAX. BACK-UP FUSE A	MODULES	ARTICLE NO.	WEIGHT g/EACH	PACKING UNIT
--	-----------------------------	-------------------------------	------------------------	---------	-------------	---------------	--------------

4-pole, short-time delayed tripping							
30	<b>25</b>	5.000	100	4	RA4203	450	1
300	<b>25</b>	5.000	100	4	<b>RA4230</b>	450	1
500	<b>25</b>	5.000	100	4	RA4250	450	1
30	<b>40</b>	5.000	100	4	<b>RA4303</b>	500	1
300	<b>40</b>	5.000	100	4	<b>RA4330</b>	500	1
500	<b>40</b>	5.000	100	4	RA4350	500	1
30	<b>63</b>	5.000	100	4	<b>RA4403</b>	500	1
300	<b>63</b>	5.000	100	4	<b>RA4430</b>	500	1
500	<b>63</b>	5.000	100	4	<b>RA4450</b>	500	1
30	<b>80</b>	5.000	125	4	RA4503	500	1
300	<b>80</b>	5.000	125	4	RA4530	500	1
500	<b>80</b>	5.000	125	4	RA4550	500	1
30	<b>100</b>	5.000	125	4	RA4603	500	1
300	<b>100</b>	5.000	125	4	RA4630	500	1
500	<b>100</b>	5.000	125	4	RA4650	500	1
30	<b>125</b>	5.000	125	4	RA4703	500	1
300	<b>125</b>	5.000	125	4	RA4730	500	1
500	<b>125</b>	5.000	125	4	RA4750	500	1

# RCCB – SENSITIVE TO UNIVERSAL CURRENT, TYPE B

RA product range – selective tripping acc. to IEC 61008

## Characteristics

- 4-pole
  - Selectively to all undelayed RCCBs (type AC, A, or B) for residual currents of all frequencies in the detection range and for residual currents of type B
  - Large range of products with
    - Rated currents from 40 A to 125 A
    - Rated residual currents 0.3 A
  - Small size for all rated currents
  - For systems with high drainage currents in the frequency range > 1 kHz
  - Very unsusceptible to transient drainage and residual currents due to high surge current strength
  - Electromagnetic compatibility in compliance with VDE 0664 part 30 and VDE 0839 part 6-2 (interference resistance for industrial use)
  - High availability, also of the voltage-dependent detection of smooth DC and AC residual currents with frequencies  $\neq$  50/60 Hz, due to full operability with mains voltages above 30 V, applied to any 2 current paths only
  - Tripping at residual currents of type A, independent of mains voltage
  - High short-circuit strength
  - Double-sided two-tier terminals for large conductor cross-section and busbar connection
  - Switch-position display
  - Window for labels
  - Multi-functional switching knob with three functions:
    - **On** (top position)
    - **Off** (bottom position)
    - Display **“tripped”** (centre position)
- If the RCCB trips due to a fault, the switching knob stays in the centre position

# RCCB – SENSITIVE TO UNIVERSAL CURRENT, TYPE B

Selective tripping acc. to IEC 61008

This product range differentiates between:

- Standard products (**shown in the table in bold**)
- Special products (shown in the table in normal print – longer delivery time)



RATED RESID. CURRENT $I_{\Delta n}$ mA	RATED CURRENT $I_n$ A	SURGE CURRENT STRENGTH > A	MAX. BACK-UP FUSE A	MODULES	ARTICLE NO.	WEIGHT g / EACH	PACKING. UNIT
--	-----------------------------	-------------------------------	------------------------	---------	-------------	--------------------	------------------

vierpolig, selektive Abschaltung							
300	<b>40</b>	5.000	100	4	RA4330S	450	1
300	<b>63</b>	5.000	100	4	<b>RA4430S</b>	500	1
300	<b>80</b>	5.000	125	4	RA4530S	500	1
300	<b>100</b>	5.000	125	4	RA4630S	500	1
300	<b>125</b>	5.000	125	4	RA4730S	500	1

## Areas of application

Commercial or industrial installations where power electronics equipment is used or can be connected, such as:

- Frequency converters
- UPS systems
- Switched-mode power supplies
- High-frequency converters
- On-site power supply distribution boards
- Photovoltaic systems

# AUXILIARY CONTACT

for all RCCBs

## AUXILIARY CONTACT FOR ALL RCCBS

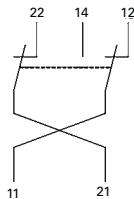

Auxiliary contact					
MO	TYPE OF CONTACT	CONTACTS	ARTICLE NO.	WEIGHT g/EACH	PAKING UNIT
1/2	2 Auxiliary contacts (1 signal contact)	1 CO + 1 NC	RH11	45	1



### 1 switch – 2 functions

With the help of a CO contact, it is possible to switch between the signal contact and auxiliary contact functions.

### Function

The RH11 can be retrofitted as an auxiliary contact or as a fault signal switch on an RCCB for all circuit breaker ranges, allowing for the display of an RCCB's operating state with the help of further output devices (buzzer, signal lamps etc.). The function setting is carried out with an actuator on the RH11.

### Auxiliary contact

Switches when the RCCB is switched on and off  
Correct function can be tested with a test button  
Fault signal switch  
Switches only when the RCCB trips (middle position)

### Characteristics

- Can switch between auxiliary contact or fault signal switch function
- Can be retrofitted
- Small size (1/2 M)
- Settable
- 1 CO contact and 1 NC contact

### Type of mounting

- Left of the RCCB with bracketing
- Any installation position

### Areas of application

Operating state queries for electricity supplies for residential and single-purpose buildings as well as industrial plants.

### Note

The auxiliary contact does not influence the RCCB.

Technical Data	Auxiliary contact and fault signal switch RH11
Rated voltage $U_n$	230 V AC / 110 V DC
Rated current $I_n$	6 A AC / 1 A DC
Switch contacts	1 x CO contact/ 1 x NC contact
Cross sections of connection lines	1 – 1.5 mm <sup>2</sup>
Terminal screw torque	0.8 Nm

# RESIDUAL CURRENT CIRCUIT BREAKERS · RP AND RW PRODUCT RANGE

RP (Type A) / RW (Type AC), Technical data

Technical data							
Characteristic	Type A (sensitive to pulsating current) / Type AC (sensitive to alternating current)						
Rated current $I_n$	16 A	25 A	40 A	63 A	80 A	100 A	125 A
Rated residual current $I_{\Delta n}$	0.01 A / 0.03 A / 0.1 A / 0.3 A / 0.5 A						
Surge current strength	0.5 $\mu$ s / 100 kHz / 200 A, ring-wave test						
Rated voltage $U_n$	230 V AC / 400 V AC						
Max. permissible operational voltage	$U_n + 10\%$						
Rated frequency	50 Hz						
Voltage operating area of the test equipment	2-pole: 100 V AC – 250 V AC / 4-pole: 185 V AC – 440 V AC						
Maximum tripping times	$1 \times I_{\Delta n} : \leq 300$ ms / $5 \times I_{\Delta n} : \leq 40$ ms						
Rated switching capacity $I_m$	500 A	500 A	500 A	800 A	800 A	1000 A	1250 A
Rated residual switching capacity $I_{\Delta m}$	500 A	500 A	500 A	800 A	800 A	1000 A	1250 A
Conditional rated short-circuit current $I_{nc}$ 2-pole	10 kA						
Conditional rated residual short-circuit current $I_{\Delta c}$ 2-pole	10 kA						
Conditional rated short-circuit current $I_{nc}$ 4-pole	10 kA						
Conditional rated residual short-circuit current $I_{\Delta c}$ 4-pole	10 kA						
Short-circuit back-up fuse	see table on page 60						
Power loss 2-pole 0,01 A (A, AC) / 0,03 A (AC)	1.5 W	3.5 W	8.0 W				
Power loss 2-pole 0,03 – 0,5 A	0.5 W	1.0 W	2.0 W	4.5 W	7.5 W	12 W	18 W
Power loss 4-pole 0,03 – 0,5 A	0.7 W	1.5 W	4.0 W	8.5 W	14 W	22 W	30 W
Installation position	any						
Degree of protection	IP20						
Resistance to mechanical shocks	20 g / 20 ms duration						
Vibration resistance	> 5g ( $f \leq 80$ Hz, duration > 30 min)						
Ambient temperature range	- 25 °C to + 40 °C						
Climatic resistance	Acc. to DIN IEC 60068-2-30: Humid heat / cyclical (25 °C / 55 °C ; 93 % / 95 % rF)						
Cross sections of connection lines Circular conductor, solid Multiple wire Stranded wire	1 x 1.5 – 50 mm <sup>2</sup> (1-conductor connection) / 2 x 1.5 – 16 mm <sup>2</sup> (2-conductor connection) 1 x 1.5 – 50 mm <sup>2</sup> (1-conductor connection) / 2 x 1.5 – 16 mm <sup>2</sup> (2-conductor connection) 1 x 1.5 – 35 mm <sup>2</sup> (1-conductor connection) / 2 x 1.5 – 16 mm <sup>2</sup> (2-conductor connection)						
Terminal screw torque	3 Nm						
Minimum conductor cross section						50 mm <sup>2</sup>	
Mechanical endurance	> 5,000 switching cycles						
Electrical endurance	> 2,000 switching cycles						
Building standards	DIN VDE 0664 T 10, EN 61008-1, IEC 61008-1						

Technical data	Differences in technical data to the RP/RW table above
Short-time delayed	
Surge current strength	3,000 A / lightning stroke current 8/20 $\mu$ s

Selective							
Rated current $I_n$			40 A	63 A	80 A	100 A	125 A
Rated residual current $I_{\Delta n}$	0.3 A						
Surge current strength	5,000 A / lightning stroke current 8/20 $\mu$ s						
Response delay	$1 \times I_{\Delta n} : 130$ ms < T $\leq 500$ ms / $5 \times I_{\Delta n} : 50$ ms < T $\leq 150$ ms						

# RESIDUAL CURRENT CIRCUIT BREAKERS · RA PRODUCT RANGE

RA (Type B), 4 pole, short-time delayed, selective, Technical data

Technical data						
Characteristic	Type B (sensitive to universal current)					
No. of poles	4					
Rated current $I_n$	25 A	40 A	63 A	80 A	100 A	125 A
Rated residual current $I_{\Delta n}$	0.03 A / 0.3 A / 0.5 A					
Tripping frequency range	Short-time delayed: 0 – 1 MHz / selective: 0 – 100 kHz					
Surge current strength	Short-time delayed: 3 kA / selective: 5 kA lightning impulse current 8/20 $\mu$ s					
Rated voltage $U_n$	230 V AC / 400 V AC					
Minimum operating voltage necessary for detecting residual currents of type A for detecting residual currents of type B	0 V (independent of mains voltage) <sup>2)</sup> 30 V AC					
Max. permissible operational voltage	$U_n + 10\%$					
Rated frequency	50 Hz					
Voltage operating area of the test equipment	185 V AC – 440 V AC					
Maximum tripping times	$1 \times I_{\Delta n} : \leq 300 \text{ ms}$ / $5 \times I_{\Delta n} : \leq 40 \text{ ms}$					
Response delay	$1 \times I_{\Delta n} : 130 \text{ ms} < T \leq 500 \text{ ms}$ / $5 \times I_{\Delta n} : 50 \text{ ms} < T \leq 150 \text{ ms}$					
Rated switching capacity $I_m$	500 A	500 A	800 A	800 A	1000 A	1250 A
Rated residual switching capacity $I_{\Delta m}$	500 A	500 A	800 A	800 A	1000 A	1250 A
Conditional rated short-circuit current $I_{nc}$	10 kA					
Conditional rated residual short-circuit current $I_{\Delta c}$	10 kA					
Short-circuit back-up fuse DIN VDE 0636 / IEC 60269-1	see table on page 60					
Power loss	1.5 W	4.0 W	8.5 W	14 W	22 W	30 W
Intrinsic consumption	max. 3.5 W					
Infeed side (res. current to 80 A) Infeed side (res. current 100/125 A)	Terminals 1, 3, 5, N <sup>1)</sup> Terminals N, 3, 5, 7 <sup>1)</sup>					
Installation position	any					
Degree of protection	IP20					
Resistance to mechanical shocks	20 g / 20 ms duration					
Vibration resistance	$> 5g$ ( $f \leq 80 \text{ Hz}$ , duration $> 30 \text{ min}$ )					
Ambient temperature range	- 25 °C to + 40 °C					
Climatic resistance	Acc. to DIN IEC 60068-2-30: Humid heat / cyclical (25 °C / 55 °C ; 93 % / 95 % rH)					
Cross sections of connection lines Circular conductor, solid Multiple wire Stranded wire	1 x 1.5 – 50 mm <sup>2</sup> (1-conductor connection) / 2 x 1.5 – 16 mm <sup>2</sup> (2-conductor connection) 1 x 1.5 – 50 mm <sup>2</sup> (1-conductor connection) / 2 x 1.5 – 16 mm <sup>2</sup> (2-conductor connection) 1 x 1.5 – 35 mm <sup>2</sup> (1-conductor connection) / 2 x 1.5 – 16 mm <sup>2</sup> (2-conductor connection)					
Terminal screw torque	3 Nm					
Minimum conductor cross section						50 mm <sup>2</sup>
Mechanical endurance	$> 5,000$ switching cycles					
Electrical endurance	$> 2,000$ switching cycles					
Building standards	DIN VDE 0664 -10, E DIN VDE 0664-100					
Electromagnetic compatibility	VDE 0664-30, VDE 0839-6-2 (Interference resistance – industrial applications)					

1) Recommended for simple insulation tests on the system side, because in this way the internal overvoltage-protection elements can be disconnected from the load side of the system by switching off the B-type RCCB.

2) For supply voltages below 30 V AC, tripping caused by A and AC-type residual currents is guaranteed due to a function independent of mains voltage.



# RCCBS · PRODUCT RANGES RP, RW AND RA

Short-circuit back-up fuses

PRODUCT RANGE		RATED CURRENT $I_n$ [A]	RATED RESIDUAL CURRENT $I_{\Delta n}$ [A]	SHORT CIRCUIT BACK-UP FUSES SCPD [A]		
2-pole	A	16	0.01	50		
		25				
		40				
		16				
		25				
		40				
	AC	63	0.03 - 0.5	100		
		16				
		25				
		40				
		63				
		100				
4-pole	A, B	16	0.03 - 0.5	100		
		25				
		40				
		63				
		80				
		100				
	AC	125	0.01	50		
		16				
		25				
		16				
		25				
		40				
		63				
		80				
		100				
		125				
		125			0.03 - 0.5	100
		100				
80						
63						
40						
25						

Rated short-circuit current  $I_{nc}$  = for all RCCBs = 10 kA

# RESIDUAL CURRENT CIRCUIT BREAKERS

## General explanations

### General explanations regarding Residual Current Operated Protective Devices (RCDs)

#### Principle

A Residual Current operated protective Device – RCD for short – continuously calculates the sum of the instantaneous values of all currents that, via the active conductors, flow into an electrical system operated in an earthed AC network.

According to Kirchhoff's Current Law, this sum must always be zero. In the case of an insulation fault, the sum of these currents is not zero, because – depending on the fault impedance  $R_F$  and the earth resistance  $R_A$  – a residual current, also called differential current or residual current, does not flow back to the current source via the active conductors, but via the earth. If the effective value of the residual current exceeds the rated residual current  $I_{\Delta n}$  of the RCD, the system is disconnected from the current source.

An auxiliary voltage source may be necessary to detect and assess the differential current, or it can be done independently of auxiliary voltage. In Germany, the term "residual current" is used when designating RCDs that detect and assess the residual current independently of auxiliary voltage, whereas the term "differential current" refers to detection and assessment depending on auxiliary voltage.

#### Protection in case of indirect contact by automatically disconnecting the power supply according to VDE 0100 - 410 (fault protection)

If – in the case of an insulation fault – earthed, conductive system parts which are not part of the operating circuit (e.g. enclosures of equipment of protection class I) have a voltage higher than the maximum permissible touch voltage  $U_{Lzul}$ , the system to be protected must be disconnected from the power supply quickly.

Earthing these parts with a sufficiently low earth resistance  $R_A$  allows for the touch voltage  $U_{Lzul}$  to cause a residual current to flow which activates an RCD and causes the system to be disconnected from the power supply immediately. To achieve this, the residual current must be higher than the rated residual current  $I_{\Delta n}$  of the RCD.

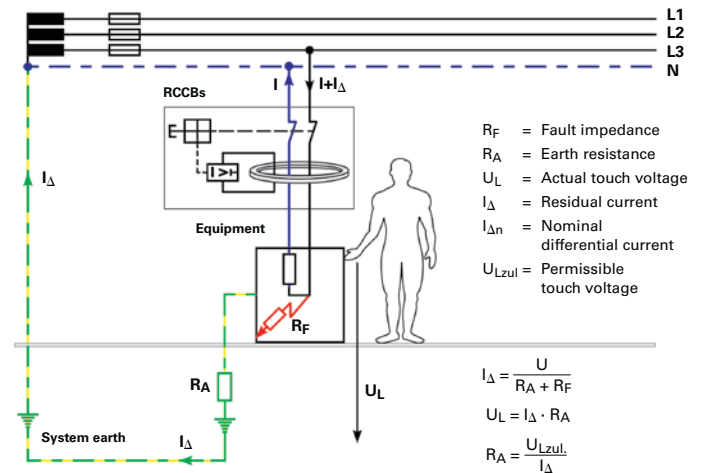

Figure 1

The maximum values for  $R_A$  for the maximum permissible touch voltages 25 V and 50 V can be found in the subsequent table. The resistance values for applications of up to -25 °C are reduced by a factor of 0.8, compared to the values for -5 °C, because the response current  $I_{\Delta}$  of the RCD at -25 °C may exceed the rated residual current  $I_{\Delta n}$  by 25%.

RATED RESIDUAL CURRENT $I_{\Delta n}$ [A]	$I_{min.}$ $U_{Lzul}$	- 5 °C 25 V [Ω]	- 5 °C 50 V [Ω]	- 25 °C 25 V [Ω]	- 25 °C 50 V [Ω]
0,01		2500	5000	2000	4000
0,03		830	1660	660	1330
0,30		83	166	60	130
0,50		50	100	40	80

Table 1

Highest permissible earth resistance  $R_A$  depending on the rated residual current  $I_{\Delta n}$  and the touch voltage  $U_{Lzul}$  at a minimum ambient temperature  $T_{min.}$  of -5 °C / -25 °C. All earth resistances must have half the value for systems with selective RCD sequences!

The interrelationships are illustrated in Figure 1.

# RESIDUAL CURRENT CIRCUIT BREAKERS

## General explanations

### Additional protection in case of direct contact according to VDE 0100-410 (operator protection)

By using high-sensitivity RCDs with a rated residual current of  $I_{\Delta n} \leq 30$  mA, additional protection in case of direct contact with an (unearthed) part conducting voltage is achieved (see Figure 2).

This additional protection is necessary if

- The insulation of totally-insulated devices or a feed cable is damaged,
- The protective conductor is interrupted,
- The protective and active conductor got mixed up and conductive parts which are normally earthed are thus energised, or
- There is contact with a part which is energised under normal operating conditions during repair work.

Based on this extended protection scope, the VDE set of standard specifications stipulates the use of a residual current circuit breaker according to VDE 0664-10 or an RCBO according

to VDE 0664-20 with  $I_{\Delta n} \leq 30$  mA for the construction of systems in areas that are particularly accident-prone.

This applies to, for example,

- Outlet circuits in rooms with a bath tub or a shower (VDE 0100-701)
- Caravans, boats and yachts as well as their power supplies at camping sites or moorings (VDE 0100-721)
- Rooms used for medical purposes (VDE 0107).

By no means must this additional protection be considered a basic protection measure since the residual current flows through the human body into the earth in case of direct contact. It is rather an “emergency brake” for the fault events mentioned above. According to VDE 0100-530, only RCDs as described in the section “RCDs for fault protection, operator protection and fire protection” on the right side may be used for additional protection.

### Fire protection

Effective protection against fires caused by earth faults can even be achieved with relatively insensitive RCDs ( $I_{\Delta n} \leq 300$  mA). For earth residual currents  $\leq 300$  mA, the electric power transferred at the fault location is normally not sufficient to ignite standard flammable materials.

Although ignition is possible for higher residual currents because of the power, the RCD switches off the power supply in less than 0.3 seconds and thus limits the electric ignition power to harmless values.

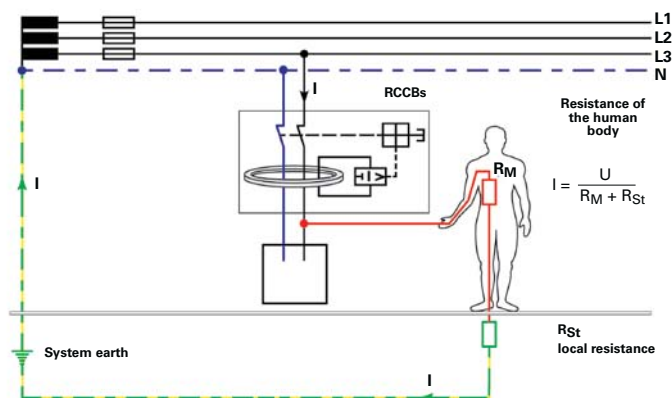

Figure 2

### RCDs for fault protection, operator protection and fire protection

According to VDE 0100-530 (construction of non-voltage systems - part 530: selecting and setting up electrical equipment, switch-gears and control gears), the following RCDs can be used for the protection targets mentioned above:

- Residual current circuit breakers according to DIN EN 61008-1 VDE 0664-10 Abbreviation: **RCCB** (Residual Current Circuit Breaker without integral overcurrent protection)
- RCBOs according to DIN EN 61009-1 VDE 0664-20 Abbreviation: **RCBO** (Residual Current Circuit Breaker with integral Overcurrent Protection)
- Circuit breakers with residual current trip according to DIN EN 60947-2 VDE 660-101 Appendix B Abbreviation: **CBR**

(Circuit Breaker providing Residual current protection)

- **Modular Residual Current Protective Devices** (abbreviation: **MRCD**) according to DIN EN 60947-2 VDE 0660-101 Appendix M whose units for measuring differential current (transformers), assessing differential current (differential current relays) and the load switch unit are accommodated in separated enclosures can be used in systems that are operated and, on a regular basis, maintained by people with electrotechnical expertise.  
In systems where it is not possible to install the devices mentioned above – e.g. because an instant switch-off means endangering people or creating a lot of material damage – **RCM** differential current monitoring devices (abbreviation for **Residual Current Monitor**) according to DIN EN 62020 VDE 0662 can be used.

# RESIDUAL CURRENT CIRCUIT BREAKERS

Technical features and application notes

## Tripping behaviour of the RCDs at different time sequences of the differential current



Only in systems whose equipment exclusively consists of linear or approximately linear electrical components – i.e. the flow of current is proportional to the voltage – can it be assumed that, in case of fault, only pure AC residual currents with the frequency of the mains voltage flow to the ground. These are components with ohmic, inductive or capacitive behaviour.

Even for sinusoidal supply voltages, equipment consisting of non-linear passive or active components such as rectifier diodes or quick switches like thyristors or transistors can cause currents that contain strong harmonics and/or whose mean values are not zero for the duration of one supply-frequency period, i.e. that have a DC component.

The residual current can also have a frequency differing from the supply frequency or consist of several partial currents with frequencies differing from the supply frequency. Therefore, RCDs with different technologies are also necessary to detect it.

The IEC 60755 technical report defines different types of RCDs as regards the time sequence of the residual currents which activate them.

This is illustrated in the following table.

RCD type	Sensitivity for differential/residual currents	Symbol
AC	Pure AC residual currents with low harmonic component i.e. sinusoidal residual currents whose mean value is zero over a period of mains frequency	
A	Residual currents of type AC and pulsating DC residual currents, whose inst. value is approx. zero ( $< 6 \text{ mA}$ ) for the duration of at least a half period of the mains frequency	
B	Residual currents of type A (i.e. also AC) as well as smooth DC residual currents and AC residual currents with frequencies up to 1000 Hz	

The table on the following page (Figure 3) shows an arrangement of usual basic circuits of equipment with non-linear components (in short: electronic equipment, EE) and the time sequences of the resulting residual currents.

Just like the form of the current curve, the fundamental frequency of the residual current also has an influence on the response behaviour of the RCDs. Therefore, the response current and the response times are only within the range of the standardised values if the residual current frequency corresponds to the rated frequency of the RCDs.

For our standard devices, it is 50 Hz.

## Area of application for A-type RCDs

After the previous explanations, it can be seen that, in case of an earth fault, AC-type RCDs are only activated within the stipulated limits if an approximately sinusoidal residual current is flowing i.e. current whose time mean value is zero and that does not show any excessive distortions (harmonic component  $< 10\%$ ).

However, electronic components in similar circuits as illustrated in the table (Figure 3) on the next page are often used for modern equipment, e.g. to increase performance.

Thus, the time sequences of the possible residual currents are no longer sinusoidal, which means that, next to the supply frequency, there are also DC components and harmonics. Even a slight DC component of the residual current makes AC-type RCDs more insensitive or completely inefficient as regards measuring the AC component. AC-type RCDs can thus only offer sufficient protection in systems whose equipment contains exclusively passive linear components and in which any later connection of non-permitted equipment – e.g. via plug connections – can be excluded.

Due to this restricted protection scope, AC-type RCDs are no longer allowed to be used in Germany and several other western European countries.

Instead, A-type RCDs are usually installed nowadays because they are also properly activated by pulsating DC residual currents. Their function is exclusively based on the principle of induction, as is the case with AC-type RCDs. Thus, they only react to residual currents that cause a sufficient change of the magnetic flow in the converter core. To achieve this, a residual current must pulsate in such a way that its instantaneous value is equal to or almost zero ( $\leq 6 \text{ mA}$ ) for at least half a supply-frequency period.

Therefore, A-type RCDs offer sufficient protection for electronic equipment with single-phase connection, except for EE with one-way rectifier and smoothing (Figure 3, circuit 2).

A-type RCDs do not react to residual currents with a high DC component or even smooth DC residual currents, as can be the case with EE with multi-phase connection (see circuits 3, 6 and 7 in Figure 3). Their intended function – reacting to A-type residual currents – even gets disturbed when there is smooth DC residual current at the same time.

Thus, according to EN 50178 / VDE 0160, EE that can create smooth DC residual currents must on no account be connected in system parts downstream of an A-type RCD.

If EE can cause residual currents with a high DC component ( $\geq 6 \text{ mA}$ ), i.e. protection by an A-type RCD is not guaranteed, the manufacturer of the equipment must point out this fact in the operating instructions.

# RESIDUAL CURRENT CIRCUIT BREAKERS

Technical features and application notes

Row	Basic circuit with fault location	Type of load current	Type of residual current	RCD tripping		
1	<b>Single-phase</b> 					
2	<b>Single-phase with smoothing</b> 					
3	<b>Full-bridge circuit</b> 					
4	<b>Full-bridge circuit, half-controlled</b> 					
5	<b>Full-bridge circuit between external conductors</b> 					
6	<b>Three-phase star circuit</b> 					
7	<b>Three-phase full-bridge circuit</b> 					
8	<b>Generalised phase control</b> 					
9	<b>Burst control</b> 					

Basic circuits of electronic equipment, time sequences of the load and residual currents as well as RCDs suitable for standard tripping

Figure 3

Source:  
E DIN VDE 0100-530; Appendix B

---

# RESIDUAL CURRENT CIRCUIT BREAKERS

Technical features and application notes

## Area of application of B-type RCDs

If equipment according to the circuits 2, 6 and 7 in Figure 3 (see previous page) can cause smooth DC residual current which is not detected by an A-type RCD, the manufacturer of the equipment must – under the terms of EN 50178 / VDE 0160 – point out that it is necessary to use a B-type RCD. This applies to almost all equipment of power electronics (EE) if it is operated in earthed networks without galvanic isolation in a three-phase manner, such as frequency converters, bigger UPS systems, welding inverters etc.

Such equipment usually delivers output voltage in the form of bipolar pulse-width modulated square-wave pulses with pulse frequencies in the range of 1 kHz up to several tens of kHz. For frequency converters, the resulting load current then has a sinusoidal shape – as a result of the inductance of the motors connected – with the desired adjusted motor frequency. Earth faults, however, normally display an ohmic resistance behaviour. That is why the output voltage of a frequency converter creates pulse-width modulated rectangular residual currents with the pulse frequency.

This means that for such applications, a RCD must also react to residual currents with the pulse frequency and their harmonics (3rd and 5th harmonic) to offer comprehensive protection. The response threshold must not exceed the maximum values permitted for a certain protection level (fault protection, fire protection or operator protection) for the whole frequency range.

Unfortunately, the current device standards do not pay the necessary attention to this point yet. The German VDE 0664-100 standard only offers details about the detection of residual current of up to 2 kHz and the international set of standard specifications IEC 60755 and the future IEC 62423 only require a residual current sensitivity of up to 1 kHz.

For these upper frequencies, residual current response thresholds of up to approx. 20 or 10 times the rated residual current are still allowed.

However, for fire protection, for example, it would be necessary to have a response frequency range of up to at least 100 kHz with an upper response threshold of a maximum of 0.3 A.

Operational drainage currents with very different frequencies constantly flowing to the ground from equipment via suppressor capacitors, for example, are a serious problem that often makes the use of RCDs difficult. If they are high enough, they can undesirably activate a B-type RCD if it detects the residual current via a broad frequency range with high sensitivity. False tripping can often be avoided by selecting the RCDs with respect to their response-current frequency response and the rated residual current.

By choosing the equipment, it is, however, recommended to guarantee even while planning the system that the sum of the

drainage currents does not exceed the lower response threshold of the RCDs and thus false tripping can be excluded.

For this purpose, we specify the frequency response of the response current for all device types in the catalogue texts of our various RCDs with tripping characteristic B.

## Designs with increased surge current strength (K type)

Pulse-shaped overvoltages caused by switching operations or thunderstorms can trigger discharge currents via the capacitance of the equipment to the ground or the interconnect capacitance resulting in undelayed RCDs being activated occasionally. Equipment with a high capacitance to the ground due to either the extensive dimensions of live parts or suppressor capacitors connected to the ground is critical in this regard.

Among the loads mentioned first are, for example, electrical panel heating and fluorescent lamps in big quantities (> 20 units per current path) with conventional ballasts.

The equipment mentioned second includes, amongst others, fluorescent lamps with electronic ballasts, X-ray equipment and computer systems. The use of our RCDs with increased surge current strength (for K-type RCCBs) is recommended to guarantee reliable operation without false switch-off even in these especially critical cases.

These devices are largely resistant to surge residual currents because of a special design of the residual current detection and assessment unit.

Testing the surge current strength is normally carried out by means of the standardised lightning stroke current 8/20 according to IEC 60060-1.

There, the peak value of the highest current surge that can flow through the RCD transformer in both directions and via all current paths without causing tripping is used as a measurement.

The surge current strength of our standard RCCBs and RCBOs is > 200 A.

The following figure on the next page shows the tripping times of an RCCB responding in an undelayed and in a delayed (selective) manner.

# RESIDUAL CURRENT CIRCUIT BREAKERS

Technical features and application notes

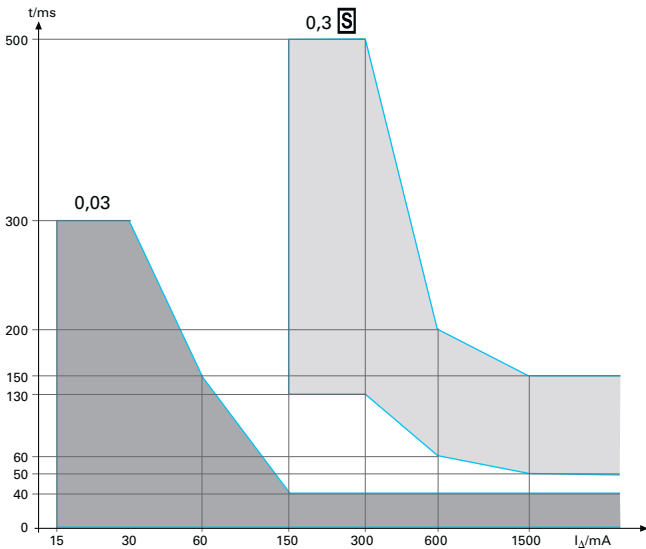

**Tripping times of an RCCB responding in an undelayed and in a delayed (selective) manner**

## Selectivity

Selective RCDs only react to the occurrence of residual current after a current flow duration of several supply-frequency periods. This makes selective tripping possible if, for example, two RCD residual current circuit breakers are connected in series, i.e. even for high residual currents, only that RCD in whose downstream system part the earth fault occurs reacts in the event of fault.

The figure below makes this correlation clear.

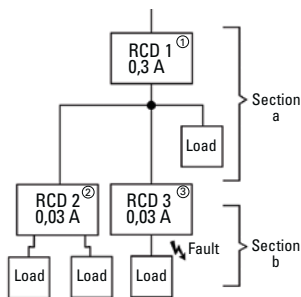

**Selective tripping if two RCDs for sequenced residual current protection are connected in series**

If an undelayed RCD was used instead of an RCD 1, every residual current  $I_{\Delta} > 0.3 \text{ A}$  in system part b would trip both RCD 1 and RCD 3.

Only the response delay of the selective RCD 1 ensures that only RCD 3 responds.

The response time of both selective and normal RCDs can depend on the amount and type of the residual current.

The above figure (tripping times) gives an example of a normal residual current circuit breaker with  $I_{\Delta n} = 30 \text{ mA}$  and a selective circuit breaker with  $I_{\Delta n} = 300 \text{ mA}$  to illustrate this.

The rated residual current of the delayed RCD must, compared to the undelayed RCD, be chosen at least one level higher to ensure selectivity in any case (i.e. also for small residual currents). In a system with selective sequences, the earth resistance  $R_A$  must not be any greater than half the value to be found in table 1 (see page 59).

In the event of fault, this enables a residual current with twice the value of the rated residual current to flow without the permitted touch voltage  $U_{LZul}$  being exceeded so that also the delayed RCCB is activated within a period of  $< 300 \text{ ms}$ .

Selective RCCBs have a surge current strength of  $> 5 \text{ kA}$ .

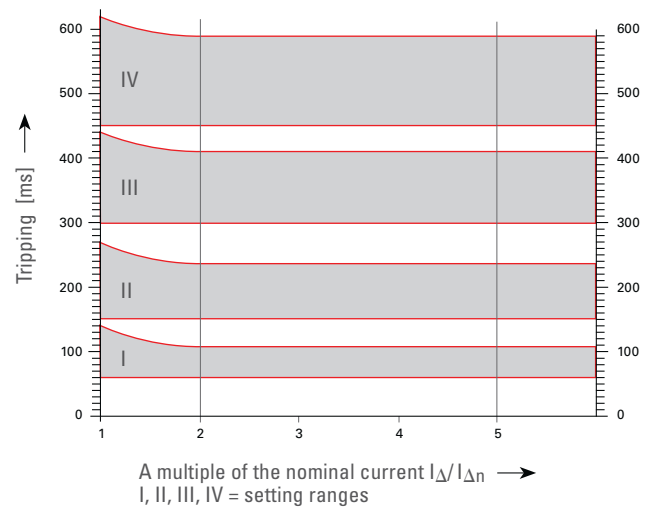
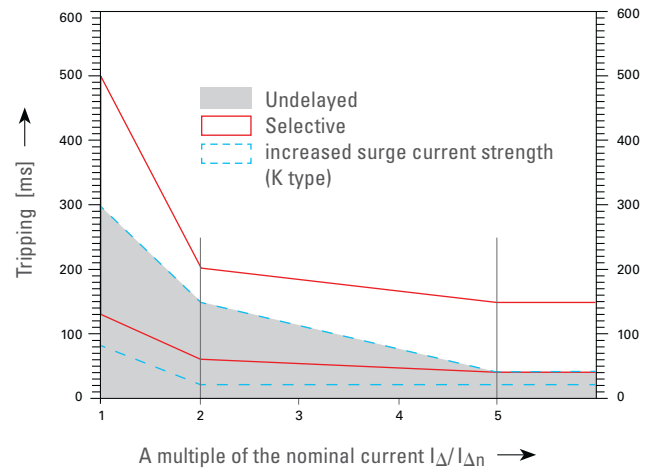

**Total tripping times for undelayed and delayed RCCBs**



# RESIDUAL CURRENT CIRCUIT BREAKERS

Technical features and application notes

## Tripping times

The figure "tripping times" on the previous page shows the tripping times of our RCCBs and CBRs depending on a multiple of the rated residual current. From this, the tripping times for circuit breakers of all rated residual currents can be determined for every desired residual current value.

## Voltage dependence

A RCD independent of the mains voltage e.g. in the form of a conventional residual current circuit breaker (RCCB) takes the energy necessary for tripping only from the earth residual current.

Even if the mains voltage drops or the neutral is disconnected, a RCCB is still functional. Even longer periods of overvoltage as a result of system disturbances have no impact on the tripping function of a residual current circuit breaker. Because of this high degree of operational reliability, a residual current circuit breaker is always to be preferred to a residual current operated protective device depending on the mains voltage.

In German systems that are not operated by personnel with technical expertise and not subject to regular maintenance carried out by experts, the basic protection measure "protection by automatic power-supply cut-off" in compliance with VDE 0100-410 must therefore only be realised with RCDs that are independent of auxiliary voltage.

Our residual current circuit breakers meet the requirement of mains voltage independence.

Our RA4xxx RCCBs, sensitive to universal current, can also be considered independent of mains voltage in terms of the DIN EN 61008-1 VDE 0664-10 standard, because they react to A-type residual currents even in the case of loss of the mains voltage, i.e. if two phases and the neutral are interrupted.

These devices only require a very little amount of auxiliary voltage, namely 30 V AC, for tripping with smooth DC residual currents and residual currents whose frequency differs from the supply frequency. This value is below the touch voltage of 50 V permitted in normal installations. Thus, the requirement of the VDE 0664-100 and even more that of the future international IEC 62423 standard is more than fulfilled.

## Ambient temperature

In almost all international standards, the normal ambient temperature range for RCDs is  $-5\text{ °C}$  to  $+35\text{ °C}$  with short-term temperatures of up to  $40\text{ °C}$  for a maximum of 1h in 24h.

Generally, our RCDs are upgraded for low temperatures of down to  $-25\text{ °C}$ . This quality is indicated by the  symbol on the nameplate of the devices.

If these RCDs are to work at temperatures below  $-5\text{ °C}$ , all

international standards grant a tripping current which is 25 % higher. The earth resistance must thus be reduced to 80 % – compared to applications at temperatures down to  $-5\text{ °C}$  – to still achieve tripping at a touch voltage of  $\leq 50\text{ V} / \leq 25\text{ V}$ .

## Short-circuit strength

RCDs must be protected against short circuits and, if it appears to be necessary, against overloading by means of suitable protection devices. The maximum prospective short-circuit current in connection with the maximum permissible back-up fuse (according to VDE 0636 utilisation category gL) is specified for our RCCBs in the data tables.

On the nameplate of the RCCB, the  symbol, for example, indicates that, in connection with a back-up fuse of 63 A, the circuit-breaker sustains a prospective short-circuit current of 10 kA.

Our RCCBs for nominal currents of up to 63 A are sufficiently protected against short circuits by a back-up fuse of 63 A. In most cases, this guarantees a short-circuit current even through the service fuse (max. 63 A).

Please note that a short-circuit fuse does not automatically guarantee overload protection.

Overload must be excluded by system planning taking simultaneity factors into account.

## Installation notes

### Mounting

Our RCDs can be used in any position. With the exception of B-type RCCBs, the infeed and load side are not defined either. 4-pole devices can also be used for 2 and 3-pole operation. Here, the voltage supply of the test equipment must be taken into account.

Mounting is carried out on DIN-rails according to DIN EN 60715. The IP40 degree of protection that can be achieved with accurate terminal covers only guarantees touch protection and limited protection against solid foreign bodies. Without additional housing, the RCDs can thus only be used in dry and dust-free rooms.

We recommend additional housing of the IP54 degree of protection for the use in rooms that are occasionally wet or in spots with increased dirt accumulation.



# RESIDUAL CURRENT CIRCUIT BREAKERS

Technical features and application notes

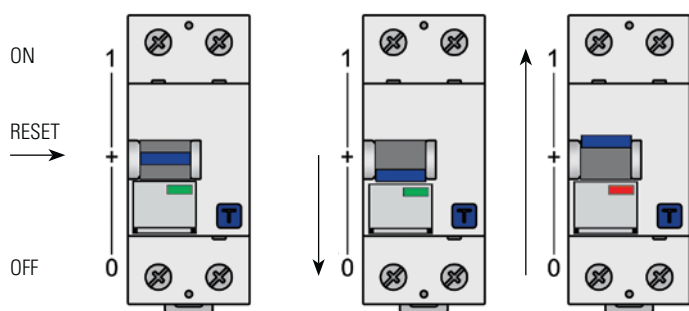

## Reset function

The switching knob is equipped with a so-called reset function.



## Residual current circuit breaker in centre position

It tripped due to a fault in the circuit. It is of utmost importance that any possible causes be checked before switching on again.



## Residual current circuit breaker in 0 position

It was switched off manually.

## Informed at a glance

On the basis of the switching knob position, it can be seen if the residual current circuit breaker was switched off by a fault (**knob is in the centre position**) or manually (**knob is in the 0 position**).

## Important note:

**For your own safety, the knob must be moved from the centre position to the 0 position to eliminate the fault. Only then can the residual current circuit breaker be switched on again!**

## Connecting and testing

Feed all conductors necessary for the operation of the system (also the neutral) through the RCCB.

Make sure all conductors are well insulated against the ground (test with insulation resistance meter). Earth the equipment to be protected. Try not to use the neutral connected upstream of the RCCB as a protective conductor (danger when neutral is interrupted before the branch point, e.g. in overhead systems). Before start-up, not only check the RCCB for correct functioning, but also the whole protective circuit (measure earth resistance and detect maximum possible touch voltage for residual currents at the tripping limit of the RCCB).

The residual current circuit breakers must be checked every six months to guarantee their smooth mechanical functioning.

## Quality characteristics

- The metal parts of the switching mechanism are made of rust-proof material
- All devices meet the requirements of the RoHS guideline, which means that all plastics used are bromine-free and halogen-free, the metal parts do not contain lead or cadmium
- All materials used are recyclable
- All electrical data is tested several times during extensive final tests and permanently allocated to every device and archived.

# RESIDUAL CURRENT OPERATED CIRCUIT BREAKER WITH OVERCURRENT PROTECTION

sensitive to pulsating currents, Type A acc. to IEC 61009

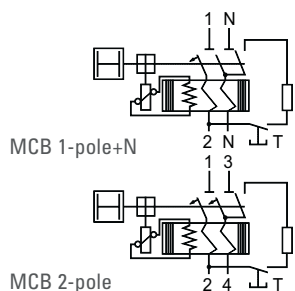

RCBOs offer a compact possibility of implementing wiring protection and protection against personal injury in one device. The RCBO protects itself through its CB part against overload. An undesired overload due to too-high load currents is not possible.

One RCBO is assigned to every circuit. So the full residual current is available to every circuit as drainage current. For one residual current in a circuit, only the affected circuit is switched off.



RATED CURRENT $I_n$ A	RATED RESID. CURRENT $I_{\Delta n}$ mA	CHARACTERISTIC		MODULES	WEIGHT g/EACH	PACKING UNIT
		B ARTICLE NO.	C ARTICLE NO.			

Short circuit withstand rating 10 kA						
MCB 1-pole + N						
6	10	RB0601	RC0601	2	225	1
6	30	<b>RB0603</b>	<b>RC0603</b>	2	225	1
6	100	RB0610	RC0610	2	225	1
6	300	<b>RB0630</b>	<b>RC0630</b>	2	225	1
6	500	RB0650	RC0650	2	225	1
10	10	RB1001	RC1001	2	225	1
10	30	<b>RB1003</b>	<b>RC1003</b>	2	225	1
10	100	RB1010	RC1010	2	225	1
10	300	<b>RB1030</b>	<b>RC1030</b>	2	225	1
10	500	RB1050	RC1050	2	225	1
13	30	<b>RB1303</b>		2	225	1
16	10	RB1601	RC1601	2	225	1
16	30	<b>RB1603</b>	<b>RC1603</b>	2	225	1
16	100	RB1610	RC1610	2	225	1
16	300	<b>RB1630</b>	<b>RC1630</b>	2	225	1
16	500	RB1650	RC1650	2	225	1
20	10	RB2001	RC2001	2	225	1
20	30	<b>RB2003</b>	<b>RC2003</b>	2	225	1
20	100	RB2010	RC2010	2	225	1
20	300	<b>RB2030</b>	<b>RC2030</b>	2	225	1
20	500	RB2050	RC2050	2	225	1
25	10	RB2501	RC2501	2	225	1
25	30	<b>RB2503</b>	<b>RC2503</b>	2	225	1
25	100	RB2510	RC2510	2	225	1
25	300	<b>RB2530</b>	<b>RC2530</b>	2	225	1
25	500	RB2550	RC2550	2	225	1
32	30	<b>RB3203</b>	<b>RC3203</b>	2	225	1
32	100	RB3210	RC3210	2	225	1
32	300	<b>RB3230</b>	<b>RC3230</b>	2	225	1
32	500	RB3250	RC3250	2	225	1
40	30	<b>RB4003</b>	<b>RC4003</b>	2	225	1
40	100	RB4010	RC4010	2	225	1
40	300	<b>RB4030</b>	<b>RC4030</b>	2	225	1
40	500	RB4050	RC4050	2	225	1

Short circuit withstand rating 10 kA						
MCB 2-pole						
10	30	<b>RB1003N</b>		3	335	1
13	30	<b>RB1303N</b>		3	335	1
16	30	<b>RB1603N</b>	<b>RC1603N</b>	3	335	1

# RESIDUAL CURRENT OPERATED CIRCUIT BREAKER WITH OVERCURRENT PROTECTION

Accessories and Busbars



## Auxiliary contact

Rated voltage  $U_e$  230V AC  
 Rated operating current  $I_e$   
 at AC-14 for  $U_e$  400V AC 3.5 A  
 at AC-14 for  $U_e$  230V AC 6.5 A  
 at DC-13 for  $U_e$  110/220V UC 0.5/0.25 A  
 at DC-13 for  $U_e$  24V UC 16 A  
 Rated current  $I_{th}$  16 A

	ARTICLE NO.	WEIGHT g/EACH	PACKING UNIT
--	-------------	---------------	--------------

1 CO	RLH1W	50	1
------	-------	----	---



CROSS SECTION (mm <sup>2</sup> )	BUSBAR CURRENT START OF BUSBAR/MIDDLE INFEEED	MODULES +H (AUXILIARY CONTACT)	PHASES	ARTICLE NO.	WEIGHT g/EACH	PACKING UNIT	SUITABLE END CAP ARTICLE NO.
----------------------------------	---	--------------------------------	--------	-------------	---------------	--------------	------------------------------

### Busbars fork type for RCBOs 2 M

#### 2-phase and 1-phase + N

10	63/110	28/2	2/1+N	SB26010	390	20	SB.A5
16	80/130	28/2	2/1+N	SB26016	430	20	SB.A2

#### 2-phase / 1-phase + N and auxiliary contact

16	80/130	22/2+H	2/1+N	SB26216	470	20	SB.A2
----	--------	--------	-------	---------	-----	----	-------

#### 3-phase + N, L1/N, L2/N, L3/N

16	80/130	27/2	3+N	SB41627	725	15	SB.A3
----	--------	------	-----	---------	-----	----	-------

### Busbars fork type for RCBOs 3 M

#### 3-phase + N, L1/N, L2/N, L3/N

16	80/130	18/3	3+N	SB41618	650	5	SB.A3
----	--------	------	-----	---------	-----	---	-------

### Busbars fork type for RCBOs 2 M

#### 3-phase + N, L1/N, L2/N, L3/N

16	80/130	6/2	3+N	G41606	135	20	-
----	--------	-----	-----	--------	-----	----	---



Busbars cannot be cut to length!

# RESIDUAL CURRENT OPERATED CIRCUIT BREAKER WITH OVERCURRENT PROTECTION

Technical data

RCBO	
Rated voltage $U_n$	230 V
Rated residual current $I_{\Delta n}$ [mA]	10, 30, 100, 300 und 500
RCCB type	sensitive to alternating current Type AC
Rated current $I_n$ [A]	6, 10, 13, 16, 20, 25, 32 und 40
Function limit for functions of the test equipment	AC 100 V
Short circuit withstand rating $I_{cn}$ (according to DIN EN 61009)	10 kA
Energy limiting class	3
Frequency	50 Hz
Number of poles	LS 1-pole+N (2 M), LS 2-pole (3 M)
Installation position	any
Degree of protection	IP 20
Connecting terminals	Both-sided multi-function terminal For simultaneous connection of conductors and pin rails
Terminal screws	± and Pozidriv 2
Torque	2 Nm
Conductor cross sections	1.5 to 25 mm <sup>2</sup>
Mechanical endurance	10,000 switching cycles (10,000 ON/10,000 OFF)
Electrical endurance	4,000 switching cycles (4,000 ON/4,000 OFF)
Standard	DIN VDE 0664-T100, EN 61009, IEC 61009

Thermal trip and short circuit trip circuit breaker			
Characteristic		B	C
Test currents	Thermal not tripping $I_1$ (A) > 1 h	$1.13 \times I_n$	$1.13 \times I_n$
	Thermal tripping $I_2$ (A) < 1 h	$1.45 \times I_n$	$1.45 \times I_n$
	Electromagnetic not tripping $I_4$ (A) > 0.1 s	$3 \times I_n$	$5 \times I_n$
	Electromagnetic tripping $I_5$ (A) < 0.1 s	$5 \times I_n$	$10 \times I_n$

# RESIDUAL CURRENT OPERATED CIRCUIT BREAKER WITH OVERCURRENT PROTECTION

Technical data

Short circuit selectivity to fuses in kA										
RCBO 10 kA										
		Rated current $I_n$ (A)								
Characteristic	B	6	10	13	16	20	25	32	40	
	C		6	10	13	16	20	25	32	40
$I_n$ (A)	16									1.)
Fuse according to DIN VDE 0636 operating class	20	0,5	0,5	0,5						
		0,5	0,5	0,5						
	25	0,8	0,7	0,6	0,6	0,5				
		0,8	0,7	0,6	0,6	0,5				
	35	1,1	0,9	0,8	0,8	0,7	0,7			
		1	0,8	0,8	0,8	0,7	0,7			
	50	2,5	2,1	2,0	1,9	1,8	1,8	1,7		
		2,3	1,9	1,8	1,7	1,6	1,5	1,4		
63	5	2,7	2,6	2,5	2,4	2,3	2,2	2,1	2	
	3	2,6	2,5	2,4	2,3	2,2	2,1	2		
80	8	5	4,2	3,8	3,6	3,4	3,3	3,2	3,1	
	8	5	4,2	3,8	3,6	3,4	3,3	3,2	3,1	
100	10	8,5	7	6,5	6,1	5,8	5,3	5,1	4,8	
	10	8,5	7	6,5	6,1	5,8	5,3	5,1	4,8	

1.) There is no more overload selectivity above the step line.

